



Simultaneous ICP Atomic Emission Spectrometers

# ICPE-9800 Series



# BEST for All Laboratories

ICPE-9800 Series of simultaneous ICP atomic emission spectrometers are next-generation systems that offer the superior accuracy necessary to simultaneously and quickly analyze multiple elements regardless of their concentration levels. They also feature user-friendly software that makes analysis easy. Furthermore, the systems reduce analysis costs while providing the highest performance levels in the industry. ICPE-9800 Series systems represent the ultimate in ICP atomic emission spectrometry for environmental, pharmaceutical, food, chemical, metal, and other fields.



Food



Environmental



Pharmaceutical



Chemical/  
Petrochemical



Metal/Electrical/  
Electronics

Simultaneous ICP Atomic Emission Spectrometers

## ICPE-9800 Series



ICPE-9810 PLASMA ATOMIC EMISSION SPECTROMETER

ICPE-9810 Axial  
ICPE-9820 Axial/Radial

## Food Products/ Agriculture

- ▶ Enhanced throughput
- ▶ Optimal methods
- ▶ Reduced operating costs



Regulations addressing hazardous elements have become increasingly stringent, as the demand grows for food safety. Moreover, labeling that lists the nutritional content of foods, in accordance with defined nutrition labeling standards, is now mandatory in many places. Such labeling generally includes minerals and other components that

support a balanced diet and an individual's health. In the area of food products, it has become increasingly important for analytical instruments to efficiently produce highly reliable data over a broad range of concentrations, whether the targets are trace hazardous elements or highly concentrated elements such as minerals.

With the ICPE-9800 Series

- Achieves a broad dynamic range from ppb to percent order due to axial and radial views. This allows comprehensive analysis of a broad range of concentrations all at once, thus enhancing throughput.
- The all-wavelengths acquisition system detects the influence of the matrix, and always offers the optimal method. Accurate analysis values can be acquired at great speed.
- Shimadzu's proprietary features (Eco mode, Mini-torch system, and Vacuum spectrometer) result in greatly reduced consumption of argon gas and less than half of total running cost.\*  
\* In comparison with purge-type instrument

Simultaneous analysis of elements in cheese and drinking water

Element		Pb	Cd	Fe	Mn	K	Mg	Na	Ca
Cheese decomposition solution	mg/L	< 0.001	< 0.0003	0.04	0.007	23.0	11.7	469	337
View orientation		Axial	Axial	Axial	Axial	Radial	Radial	Radial	Radial
Drinking water	mg/L	< 0.001	< 0.0003	0.06	0.005	0.70	2.95	4.48	12.5
View orientation		Axial	Axial	Axial	Axial	Axial	Axial	Radial	Radial

## Environment/ Tap Water/Waste Water

- ▶ Reduced analysis times
- ▶ Superior stability over long periods
- ▶ High sensitivity



The environmental field requires robust, high-sensitivity analysis capable of complying with regulations in order to always meet the stringent target values that have been established to assure the

safety of the water supply and protect the environment. Moreover, in laboratories where more than 100 samples are processed per day, increasing the throughput and saving energy are issues of concern.

With the ICPE-9800 Series

- Offering the highest level of robustness, the sample injection system (vertical torch orientation) is designed to minimize torch clogging and memory effects. Even with boron, which tends to produce memory effects, measurements can be repeated with short rinse times, thus resulting in a shorter analysis time.
- The axial view has been optimized in order to provide the utmost in sensitivity.
- Realize an even higher level of sensitivity by making use of the optional ultrasonic nebulizer or a hydride generator.

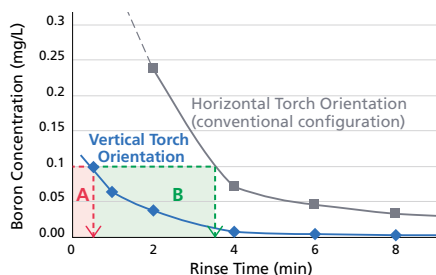

Boron Memory Test Data  
Blank sample measured after injecting 100 mg/L boron for about 2 minutes

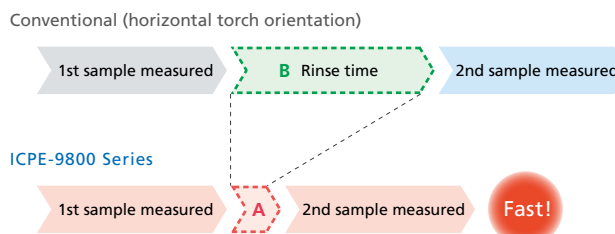

**ICPE-9800 Series**

Simultaneous ICP Atomic Emission Spectrometers

## Medical/ Pharmaceutical

- ▶ High sensitivity
- ▶ Automatic correction for spectral interference
- ▶ No need for oxygen when introducing organic solvents



The ICH Q3D guideline established, which aims at harmonization among the regulatory authorities in Japan, the U.S., and the EU concerning the analysis of elemental impurities in drugs. The regulations by individual authorities are accordingly revised. As part of the quality control measures for pharmaceuticals, detection limits

must meet the stringent permitted daily exposure (PDE) values. Validation is also important to guarantee the reliability of analysis values. Moreover, measuring organic solvents, such as DMF, that are commonly used for the dissolution of samples requires simplicity and stability.

### With the ICPE-9800 Series

- Highly sensitive, large, 1-inch CCD detector satisfies strict detection limit requirements.  
In addition to being highly sensitive, the instrument always acquires data for all wavelengths. This makes it easy to quickly confirm the effect of matrix interference when analyzing tablets or capsules with matrices such as titanium oxide.
- The torch is designed to resist the adhesion of carbon, thereby allowing the direct analysis of organic solvent samples without introducing oxygen.  
This realizes stable analysis without the expenditure of extra costs or time.

### Analysis of ICH Q3D Guideline for Elemental Impurities in Drug Products by ICP-AES

Element	Oral PDE	Permissible Concentration	Concentration after Processing	Additive Concentration	Measured Value (in tablet)	Recovery of Additive	Tablet Conversion Detection Limit (3σ)
	µg/day	µg/g	µg/mL	µg/mL	µg/g	%	µg/g
As	15	75	1.5	0.5	< DL	107	0.5
Cd	5	25	0.5	0.1	< DL	100	0.007
Hg	30	150	3	1	< DL	101	0.1
Pb	5	25	0.5	0.1	< DL	98	0.07

• PDE: ICH Q3D step 5

For analysis results covering all 24 elements refer to relevant *Application News* No. J99

## Chemicals/ Petrochemicals

- ▶ Stable injection of organic solvent samples and high-salt samples
- ▶ User-friendly software
- ▶ Reduced operating costs



In the chemical field, ICP-AES is used for a broad range of analysis in order to manage trace amounts of hazardous metals in the manufacturing process, manage additive elements essential to the functionality of a product, and manage the environment of the entire factory. Therefore, it is desirable to have a robust, highly

stable system able to reliably accept the injection of a broad variety of samples, regardless of the type of solvent (aqueous/organic) or the presence of matrices. It is also important to simplify processes and reduce costs, which enhances the productivity of daily quality control work.

### With the ICPE-9800 Series

- The vertical orientation of the torch, which reduces memory effects, ensures stable analysis results even for samples with high concentrations of acids or salts, or for a variety of organic solvents.
- Optimal options for introducing sample with high concentrations of salts, organic solvents and hydrofluoric acids are prepared.
- With greatly enhanced usability, the latest software (ICPEsolution) makes everyday analysis even easier and simpler.
- Shimadzu's proprietary features (Eco mode, Mini-torch system, and Vacuum spectrometer) result in greatly reduced consumption of argon gas.\* ICPE-9800 guarantees operation with argon gas 99.95% purity. Using industrial argon gas with lower price makes greatly cost reduction.  
\* In comparison with purge-type instrument

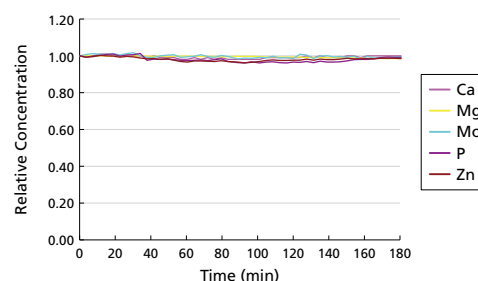

Stability in Continuous 3-Hour Measurement (engine oil)

## Metals/Mining/ Electrical and Electronic

- ▶ Easy to check for interference from matrix components
- ▶ High accuracy
- ▶ Long-term performance stability



In fields related to metals and electrical/electronics, ICP-AES is primarily utilized for quality control of materials. The demand is for high-accuracy analysis and long-term stability. Additionally, with minerals and electronic waste materials, for example, there are

sometimes complicated, high matrix samples. In such cases, it is important to avoid interference in order to obtain reliable analysis results.

### With the ICPE-9800 Series

- Obtain accurate measurement values, even when analyzing complicated materials, using the data acquired for all wavelengths, plus a comprehensive wavelength database that includes interference data.
- Achieve the highest level of reproducibility and long-term stability due to the instrument's proprietary high-frequency power source, a sample injection system that leaves no memory effects, and a robust optical system.
- The axial view unit can be removed, and the system can be used exclusively for radial view.

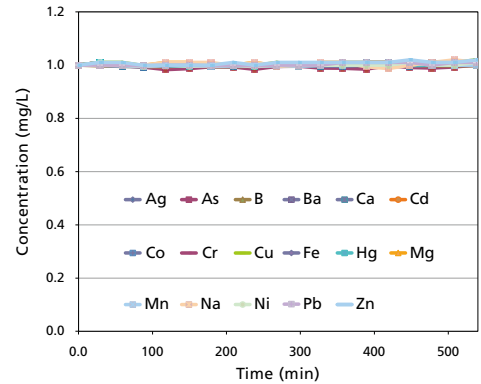

Stability in Continuous 9-Hour Measurements (Aqueous)  
1 mg/L Solution of Each Element  
Continuous 9-Hour Measurements with Axial View

## Elements Analyzed by the ICPE-9800 Series

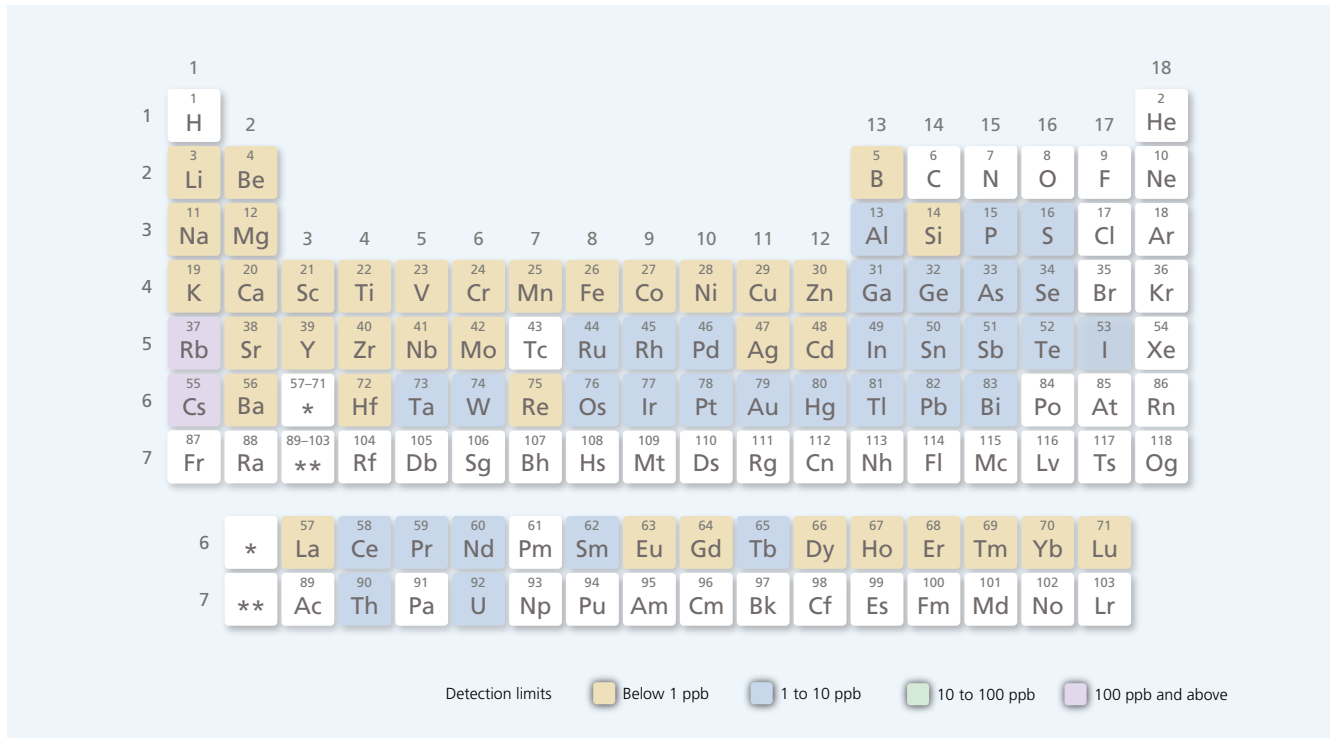

# High Performance

## System Design Ensures Maximum Performance

- Photometric System Highly Suitable for the Analysis of a Wide Variety of Samples
- Leading-Edge CCD Detector with One Million Pixels Capable of Simultaneous Recording of All Wavelengths
- Three Features Reduce Gas Consumption by Half



# Highly Suitable for the Analysis of a Wide Variety of Samples

## Simultaneous Analysis of Trace and High-Concentration Samples Without Concern for Contamination

The torch is oriented vertically to minimize any adhesion of sample on the torch walls, thus reducing memory effects. Simultaneous analysis is possible by switching between axial and radial views.

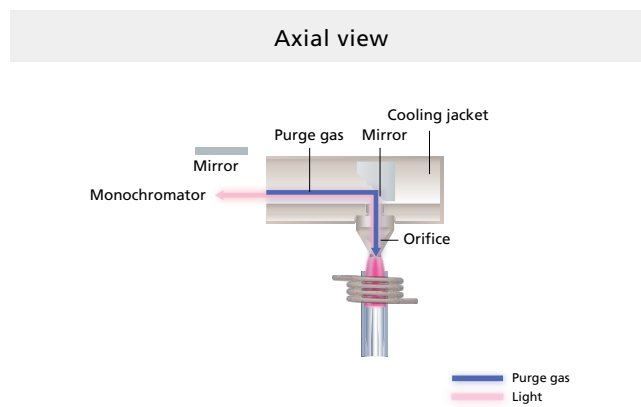
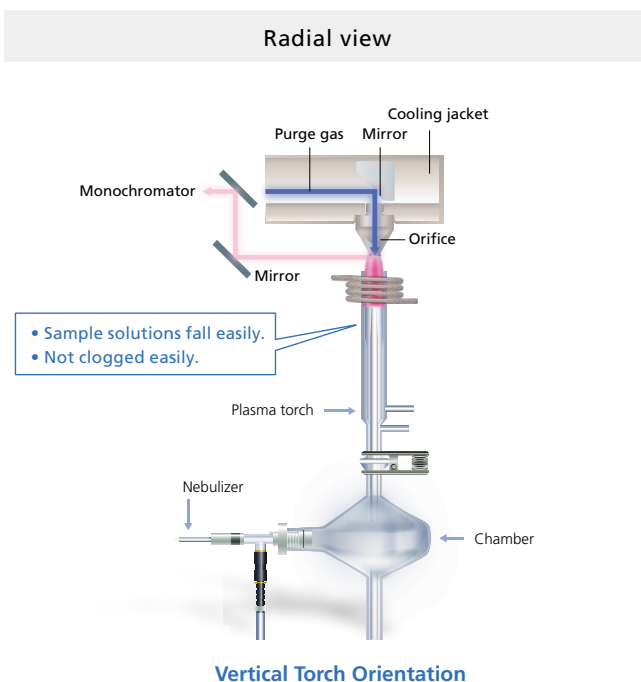

The axial view of the ICPE-9800 series uses the photometric unit (cooling jacket plus orifice) installed perpendicular to the torch. In axial measurements, the system causes a small amount of purge gas to flow in the axial direction in order to eliminate the upper low-temperature portion of the plasma and capture the hot portion. This prevents contamination of the photometry unit.

## Analysis of High-Concentration Range and Organic Solvent Samples

Cooling Jacket Removal, Specifically for Radial View

ICPE-9820

When analyzing the high-concentration range, or when introducing organic solvent samples, the cooling jacket can be removed to use the unit exclusively for the radial view. Removing the cooling jacket is easy.

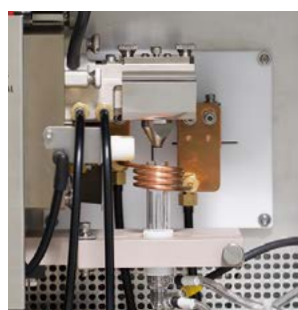

Axial & Radial view



Radial view only

## Simplifies Organic Solvent Measurements

No oxygen gas (auxiliary gas) is necessary for analyzing organic solvents, such as drugs dissolved in DMF or petroleum products diluted with xylene. The optimized plasma conditions and torch layout significantly reduce carbon deposits on the torch tip, thus enabling stable analysis. Also, since oxygen gas cylinders or gas flow lines are not necessary, it eliminates the need for associated installation work or other additional expenses.

# Leading-Edge CCD Detector with One Million Pixels Capable of Simultaneous Recording of All Wavelengths

Data for all wavelengths are captured as an image formed on a two-dimensional plane using a large 1-inch CCD sensor, in the same way that a camera captures a photograph. The acquired data are saved for reviewing at any time. The wavelength can be changed after the measurement is finished, thus reducing the need to reanalyze samples and enabling faster method development. In addition, qualitative data can be read and matrix elements can be checked and corrected for, thus eliminating measurement errors due to interference.

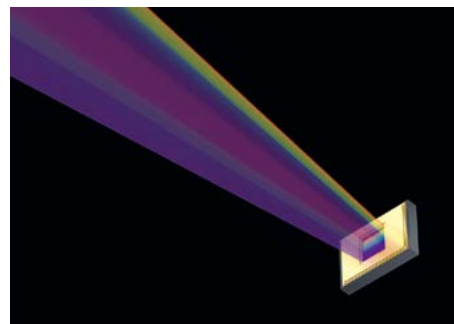

## Anti-Blooming

One-Inch Back-Illuminated CCD Detector

Since the instrument employs a back-illuminated CCD with overflow drains, it provides a broad light receiving area, while also preventing blooming

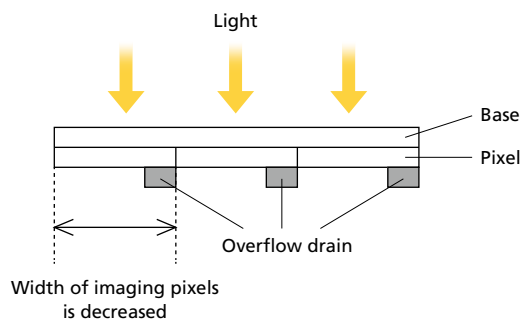

## Automatic System Shutdown After Analysis

The cooling temperature of the CCD is  $-15^{\circ}\text{C}$ , which means it can be used at a higher temperature than a conventional semiconductor detector ( $-30^{\circ}\text{C}$  to  $-40^{\circ}\text{C}$ ). The waiting time at shutdown that is usually required in order to prevent condensation is not necessary.

## High Sensitivity and High Resolution

Schmidt-aberration Corrected

A Schmidt mirror is used for correcting astigmatism. Spectrometers without this function result in blurring along the perimeter of the detector, which decreases resolution and sensitivity.

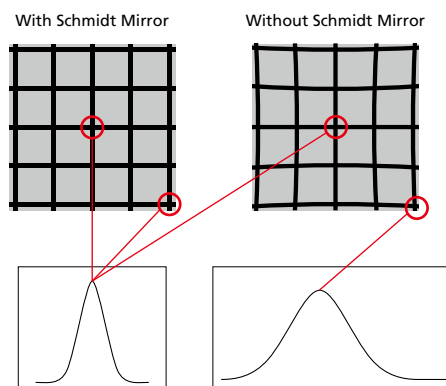



# Three Features Reduce Gas Consumption by Half

## Gas Usage During Analysis and Standby Halved

### Mini Torch



Mini-torch is designed to have only half the cross sectional area of standard torches. Applying the same high-frequency output to the smaller cross section increases the energy density per cross section. This improves the excitation efficiency, resulting in higher sensitivity.

### Eco Mode



Reducing the high-frequency output to 0.5 kW and the plasma gas flow rate to about 5 L/min during standby saves energy and reduces costs. The analysis mode starts up smoothly as well, which enables stable analysis.

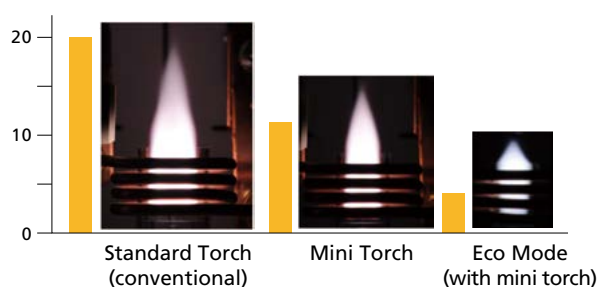

## Reduced Startup Gas Consumption

### Vacuum



To enable measurements of wavelengths in the vacuum UV region (below 190 nm) ICPE-9800 systems employ a vacuum pump (rotary pump) to evacuate the air and remove oxygen from inside the spectrometer. This ensures a shorter startup time in comparison to purge-type systems. When the pump stops, a solenoid valve automatically closes to maintain the vacuum inside the spectrometer. Consequently, there is no need to worry about contamination from atmospheric air flowing back into the spectrometer after the pump stops.

### Advantages of Vacuum Spectrometers

- Lower operating costs
- Faster startup and shutdown  
Startup takes about 10 minutes. Also, the system can be switched OFF immediately after measurements.

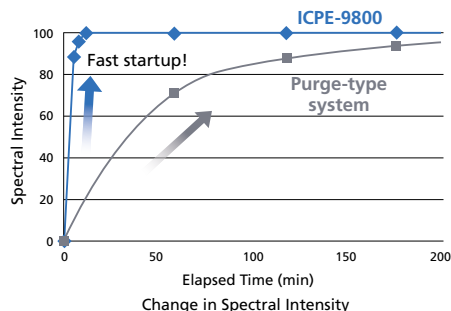

## Sample Introduction System Achieves Stable Analysis for Long Periods of Time

### Natural Aspiration and Gravity Drain

The sample introduction system incorporates a high-accuracy nebulizer for introduction by free aspiration and a gravity drain. Therefore, a peristaltic pump is not necessary. Since there is no need to worry about a reduction in the efficiency or the variability of introduction caused by the deterioration of the pump tube, or trouble caused by improper draining, stable analysis can be accomplished for long periods of time. (If you wish to automatically add an internal standard element, an optional peristaltic pump should be used.)



# Smart Assist

ICPEsolution Software  
Ensures a Smoother  
Analysis Process



# ICPEsolution Software Ensures That Analysis Can Be Started Smoothly

Start measurements easily by simply clicking icons on the assistant bar in order.

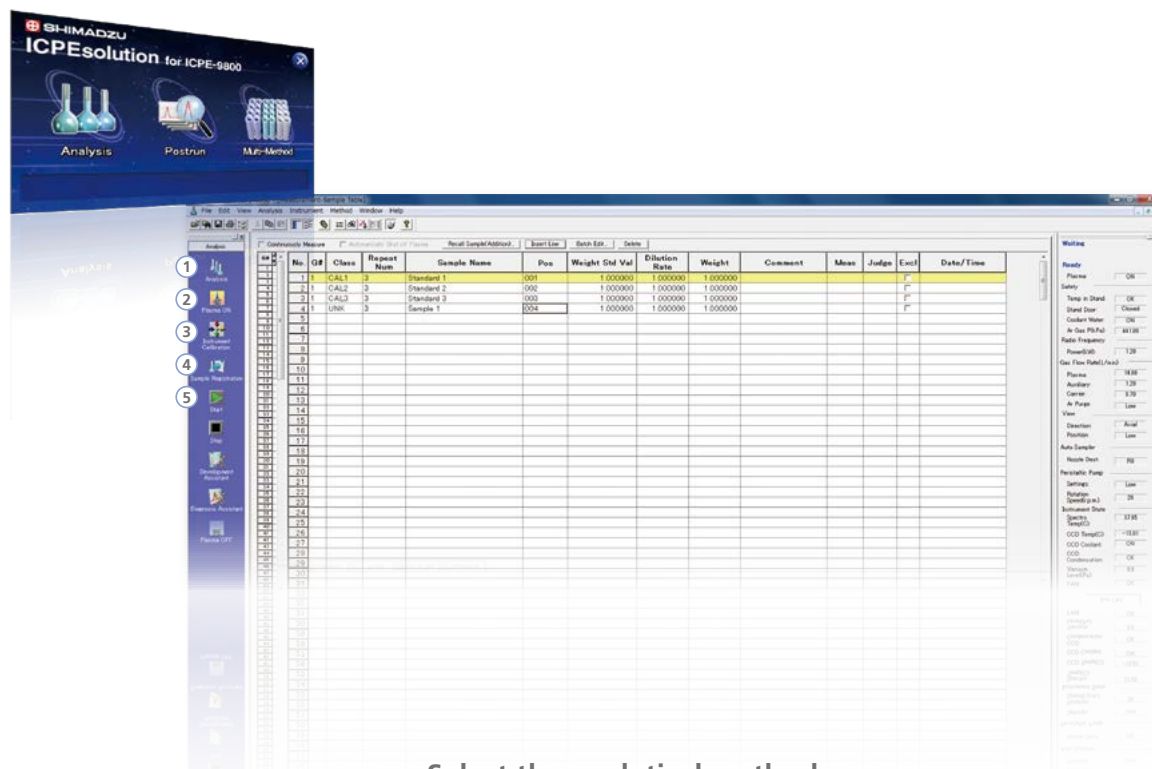

1



## Select the analytical method

System methods:  
Methods (with plasma conditions and other settings) optimized for the sample injection system are available.

User methods:  
Methods used on a routine basis can be specified and registered.

2



## Ignite the plasma

3



## Calibrate the instrument (wavelength calibration)

Standard samples are not necessary for wavelength calibration.

4



## Register the sample

5



## Start the measurement

## Acquisition for All Wavelengths and Assistant Functions Ensure a Smoother Analysis Process

The ICPE-9800 series' assistant functions, which combine extensive spectral data with a substantial database, enable easy optimization of methods and a simpler, more efficient analytical workflow.

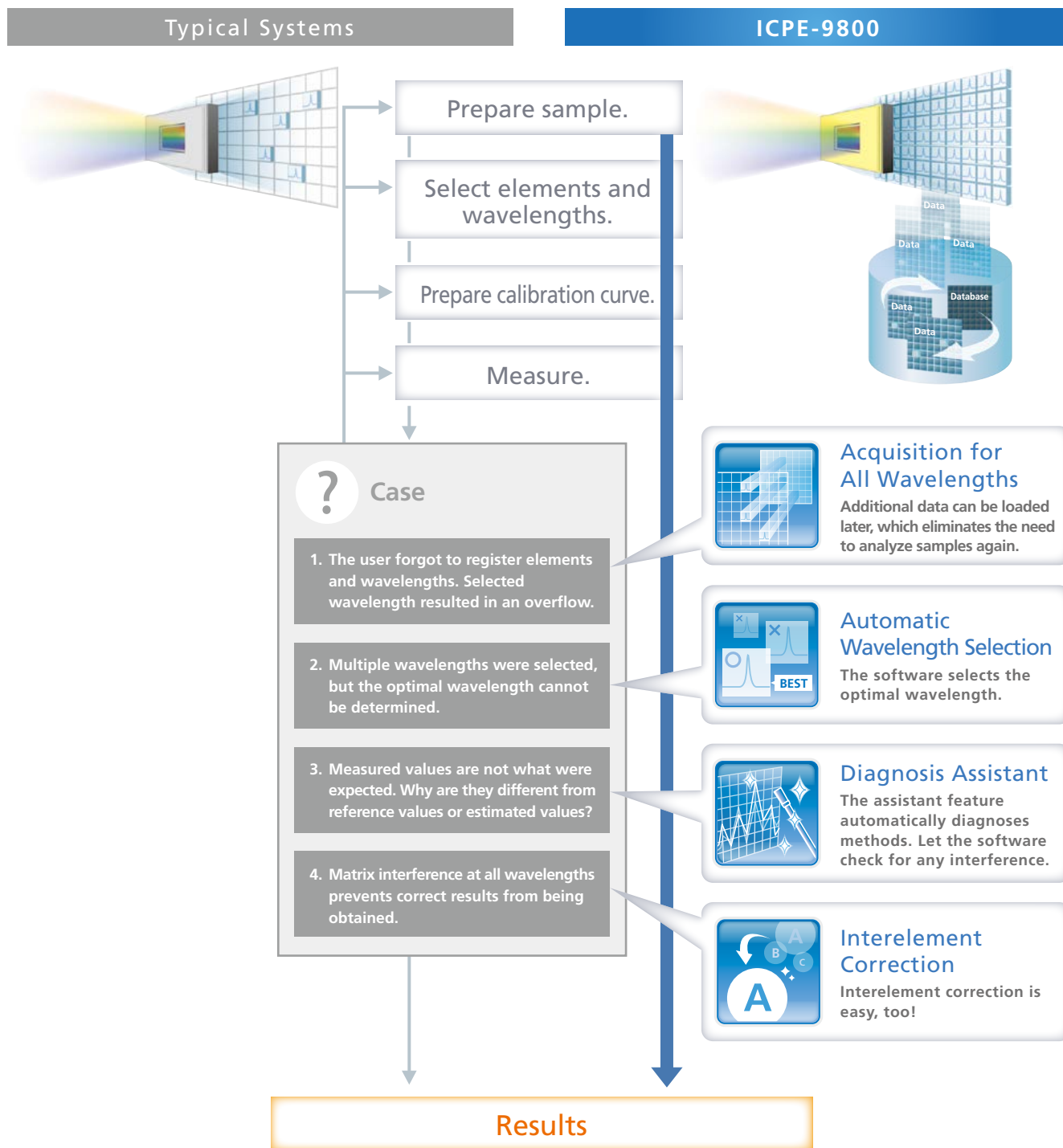

## Acquisition for All Wavelengths Allows You to Freely Add Elements and Wavelengths



### Acquisition for All Wavelengths

Even after measurements are finished, the elements and wavelengths can be added, which allows you to confirm the quantitative or qualitative data. Because data are acquired for all wavelengths, there is no need to reanalyze samples.

#### Adding Quantitative Analysis

The quantitative values can be displayed by simply adding elements or wavelengths. This is especially helpful when you forgot to specify an element to be measured or want to obtain data for other wavelengths.

#### Adding Qualitative Analysis

The profiles and semi-quantitative values can be loaded and confirmed for all elements. This is useful for determining the approximate concentrations of elements that were not quantitated, for example to confirm matrices.

#### Reanalyzing Data from Previous Analyses

Once data for all wavelengths have been saved, it can be loaded and reanalyzed at any time. This availability of data provides peace of mind in case something unexpected happens with quality control or when analyzing samples that are only available in small quantities.

## Three Functions Make Method Optimization Easy



### Automatic Wavelength Selection

This function automatically selects the optimal wavelengths for the measurement sample based on the SB ratio and whether or not there is interference from the matrix.

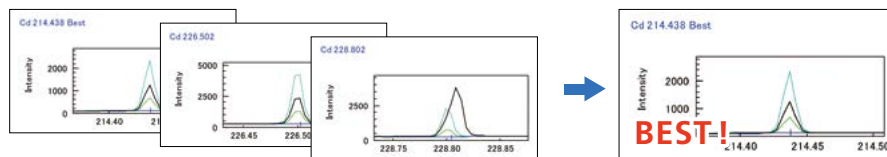

### Diagnosis Assistant

This function automatically checks for any problems with the method and, if any are discovered, it suggests the best way to resolve them. This allows anyone to quickly obtain accurate analytical values.

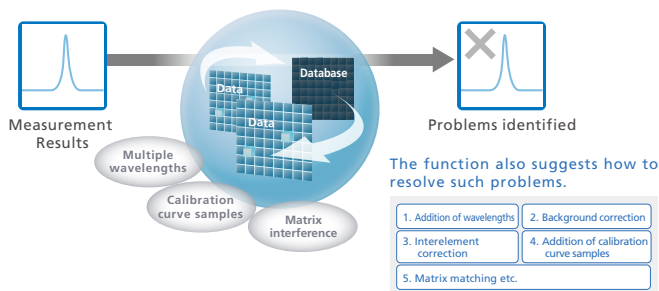

### +α Also Smart At Creating Methods Before Analysis



### Interelement Correction

This function is useful if high-matrix samples cannot be quantitated accurately due to optical interference at all analytical wavelengths. ICPEsolution software allows users to easily perform interelement correction by simply adding a calibration sample for the interfering element to the calibration curve sample.



### Method Development Assistant

This function uses the results of qualitative analysis to automatically create a method (including wavelengths and calibration curve concentrations) depending on the concentrations of the elements targeted for measurement and the matrix in the sample. User method development can be performed smoothly.

# Lowering Operating Costs

## Three Features Minimize Gas Consumption, Leading to Cost Savings

ICPE-9800 systems include three features for reducing gas consumption (Eco mode, Mini-torch system, and Vacuum spectrometer), which significantly reduce the amount of argon gas consumed.



### Eco Mode

An Eco mode has been added to reduce argon gas consumption to about half the normal level and high-frequency output to about half the normal level while in standby mode. The plasma gas flow rate is automatically reduced during standby mode, and the system enters the Eco mode. When a sample is placed in position and the measurement start icon is clicked, the system automatically returns to analysis mode and starts measurements.



### Mini-Torch System

Mini-torch consumes only about half as much argon gas as standard torch.



### Vacuum Spectrometer—No Purge Gas Required

Unlike purge-type spectrometers, the vacuum spectrometer does not need to be purged continuously with high-purity argon or nitrogen gas.

## Analysis Example

In this example, about 120 samples were measured for six hours in a day, with preparation time provided (for preparing samples and taking rest breaks) between the measurements.

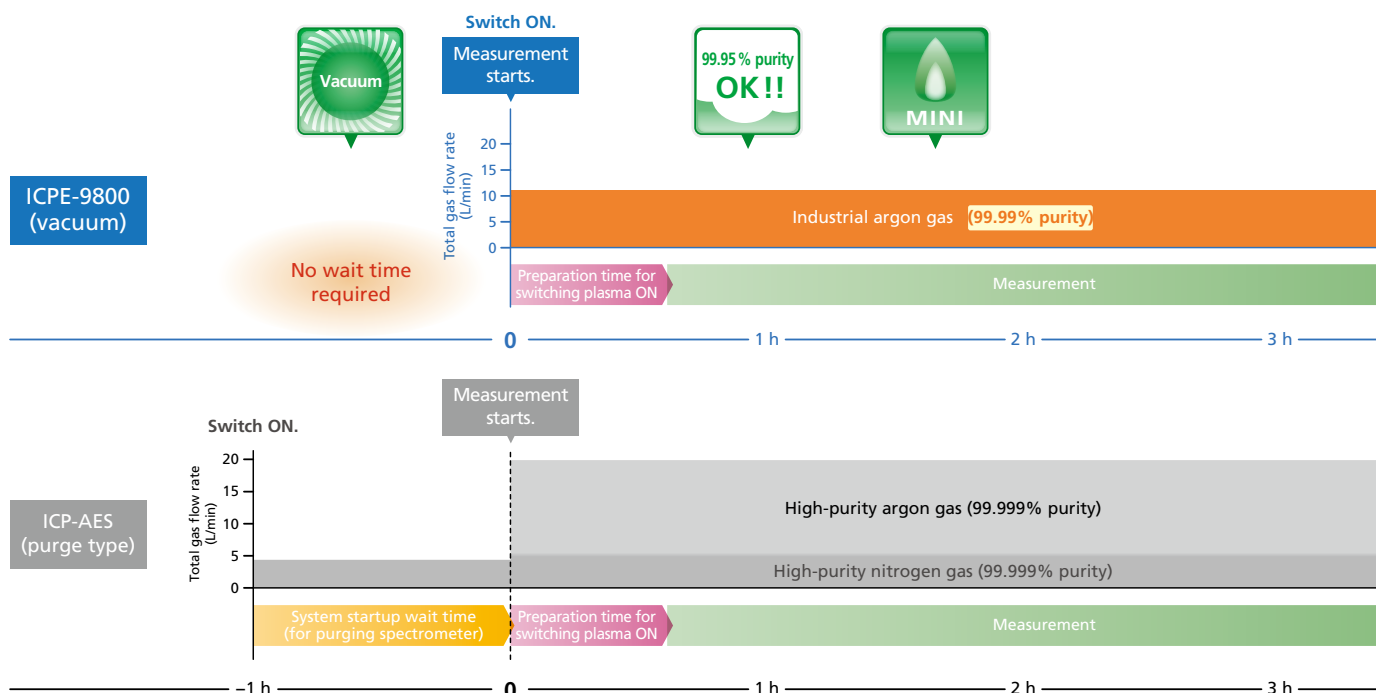

### Estimates Example

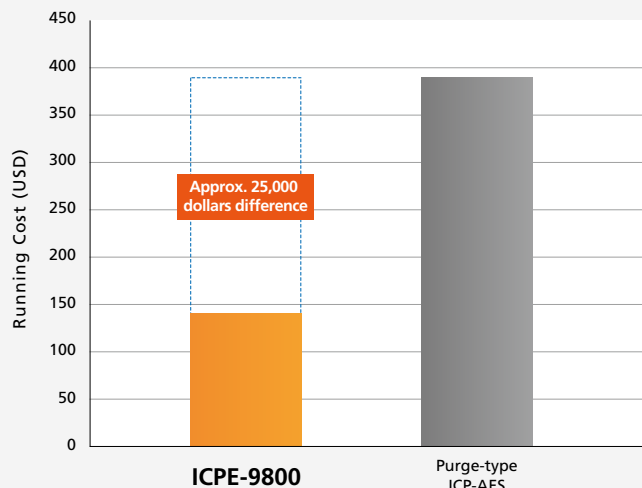

### ICPE-9800 reduce running cost to less than half

#### Example of Running Cost Calculation:

If ICPE-9800 is running for six hours in a day, 12 times in a month for three years under the analysis example at the bottom of this page, approximately 25,000 dollars can be saved compared to purge type instrument.

Calculated on the assumption that the ICP-AES purge-type spectrometer uses high-purity nitrogen gas. In this case, nitrogen plumbing is required. If high-purity argon gas is required, the running cost would be even higher (approx. 45,000 dollars per 3 years).

#### Purity and Prices of Argon gas\*

Industrial Argon gas 99.99% : USD 50  
 High-purity Argon gas 99.999% : USD 100  
 High-purity Nitrogen gas 99.999% : USD 70

\*As of October 2013, according to Shimadzu survey. Prices depend on the regions or local gas distribution companies.







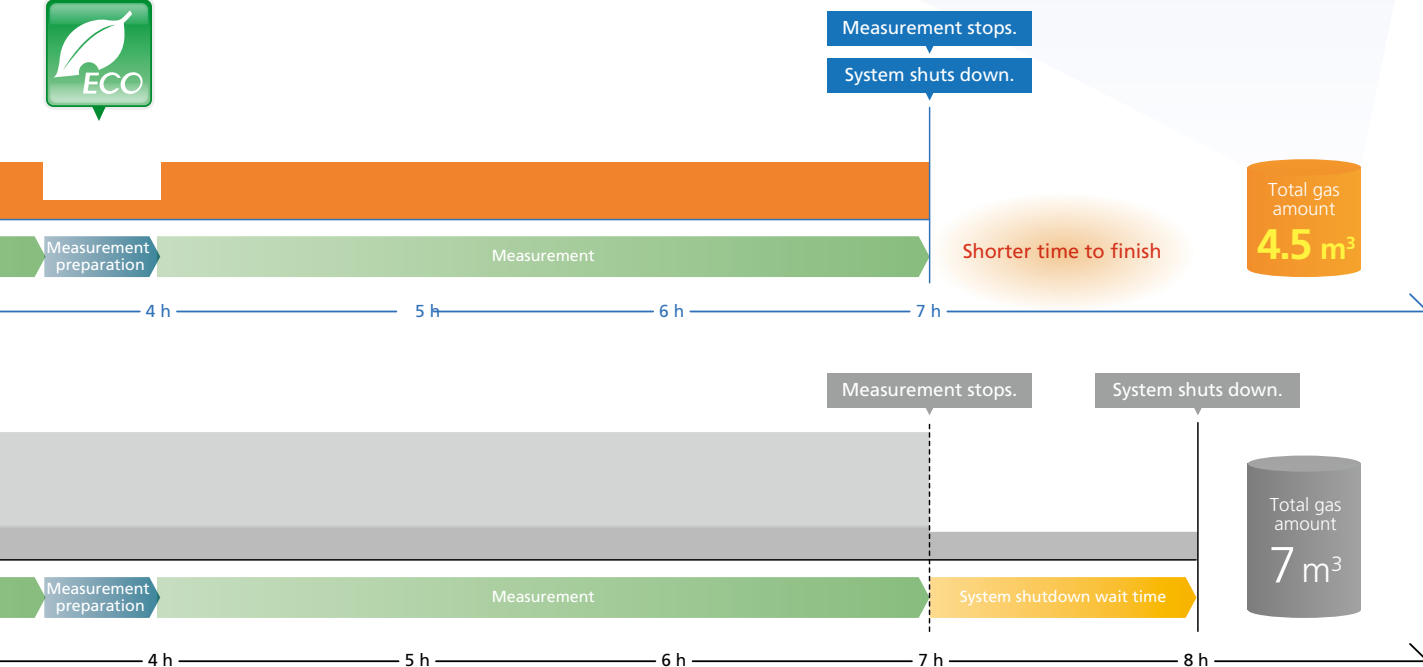



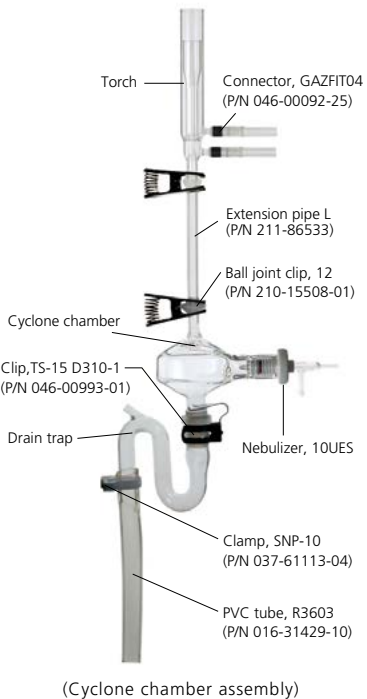

#### Argon gas of 99.95% or greater purity is enough

ICPE-9800 guarantees operation with argon gas 99.95% purity. Using industrial argon gas with lower price makes greatly cost reduction. Expensive argon gas over 99.999% purity, which is used at conventional ICP is not necessary.















# Accessories

	(Standard Set)	For High-Salt Samples	For Organic Solvents (1)
<p>Standard Set ICPE-9800 Standard Accessories</p> 	<p><b>Examples of Samples</b></p> <p>Environmental water, waste water, food decomposition solutions, and other acid decomposition solutions</p>	<p><b>For High-Salt Samples</b></p> <p>Salt and principal elements contained in percent-level concentrations</p> <ul style="list-style-type: none"> <li>• Seawater</li> <li>• High-concentration metal solutions</li> </ul>	<p><b>For Organic Solvents (1)</b></p> <p>Organic solvents with low volatility</p> <ul style="list-style-type: none"> <li>• DMF</li> <li>• Xylene</li> <li>• Ethanol</li> </ul>
	<p><b>Torches</b></p> <p><b>Mini-Torch</b> (P/N 211-81448)</p> <p><b>Orifice L2 ASSY</b> (P/N 211-87758-42)</p> <p>Note: Mini-Torch Only</p> 	<p><b>Torch for High-concentration Salt Solution Samples</b> (P/N 204-74323)</p> <p>Used when introducing a sample solution where the base element is in % order of concentration.</p> <p><b>Orifice S2 ASSY</b> (P/N 211-88571-42)</p> 	<p><b>Torch</b> (P/N 211-92878-41)</p> 
	<p><b>Chambers</b></p> <p><b>Cyclone Chamber, HE</b> (P/N 046-00093-02)</p>  <ul style="list-style-type: none"> <li>• Locking screw, 0152 (P/N 046-00093-92)</li> <li>• Seal, 0237 (P/N 046-00093-93)</li> </ul> <p>These are included.</p>		<p><b>Organic Solvents Chamber</b> (P/N 211-90552)</p>  <p><b>Nebulizer Holder Kit, Type 2</b> (P/N 211-48062)</p> <p>This kit includes O-rings that are resistant to organic solvents. It can be attached to any of the chambers other than the cyclone chamber to support a nebulizer.</p> 
	<p><b>Nebulizers</b></p> <p><b>Nebulizer, 10UES</b> (P/N 046-00092-20)</p> <p>Designed for high-concentration samples, with high-efficiency nebulization. (Sample suction rate of approx. 1 mL/min)</p> <ul style="list-style-type: none"> <li>• Suction Tube, NFTS-075 (P/N 046-00092-18)</li> <li>• Connector, QSM (P/N 046-00092-09)</li> <li>• Tube adaptor, 0735 (P/N 046-00092-10)</li> <li>• Clamp, SNP-1 (P/N 037-61113-01)</li> </ul> <p>These are included.</p> 		
	<p><b>Drains</b></p> <p><b>Drain Trap, 8214</b> (P/N 046-00093-01)</p> <p>For cyclone chambers</p> 		<p><b>Drain Trap (for organic)</b> (P/N 211-90553)</p>
		<p><b>Other</b></p> <p><b>Water Bubbler</b> (P/N 204-19281)</p> <p>Used to prevent blockages in the nebulizer when analyzing samples containing large amounts of sodium. Inserted in the carrier gas pathway.</p> 	
			<p><b>Kit</b></p> <p><b>Organic Solvents Chamber System</b> (P/N 211-92879-41)</p> <p>This kit includes chamber, drain and some parts attached them. In addition to this kit, torch is required for new purchase.<sup>Note</sup></p>



For Organic Solvents (2)	For Hydrofluoric Acid Resistance
<p>Organic solvents with high volatility</p> <ul style="list-style-type: none"> <li>• THF</li> <li>• Acetone</li> </ul>	<p>Solutions with residual hydrofluoric acid</p>
<p><b>Organic Solvent Torch</b> (P/N 211-92876-41)</p> <p>Used when analyzing organic solvent samples that are difficult to inject into the plasma.</p> 	<p><b>Demountable Torch for Hydrofluoric Acid</b> (P/N 211-92893-41)</p>  <p><b>Orifice S2 ASSY</b> (P/N 211-88571-42)</p> 
<p><b>Organic Solvents Water-Cooled Chamber Kit</b> (P/N 211-90551)</p> <p>This increases injection efficiency of organic solvent samples by cooling the chamber and suppressing sample evaporation within the chamber.</p>  <p>Note: Cooling water circulator is necessary.</p> <p><b>Nebulizer Holder Kit, Type 2</b> (P/N 211-48062)</p> <p>This kit includes O-rings that are resistant to organic solvents. It can be attached to any of the chambers other than the cyclone chamber to support a nebulizer.</p> 	<p><b>Cyclonic Spray Chamber for Hydrofluoric Acid</b> (P/N 046-00093-05)</p>  <p><b>Extension Pipe for Hydrofluoric Acid</b> (P/N 211-84175)</p>
	<p><b>Nebulizer, PFA15</b> (P/N 046-00092-17)</p> <ul style="list-style-type: none"> <li>• Suction Tube, NFTS-075 (P/N 046-00092-18)</li> <li>• Tube assembly, 70-803-0911 (P/N 046-00092-19)</li> <li>• Connector, QSM (P/N 046-00092-09)</li> <li>• Tube adaptor, 0735 (P/N 046-00092-10)</li> <li>• Clamp, SNP-1 (P/N 037-61113-01)</li> </ul> <p>These are included.</p> 
<p>solvents)</p> 	<p><b>Hydrofluoric-Acid-Resistant Drain</b> (P/N 046-00093-06)</p> 
<p><b>Thermostat, NCB-1210B SP</b> (P/N 044-01916-01)</p> <p>For Water-Cooled Chamber Size: W210 × D430 × H639 mm, 29 kg Power supply: Single-phase, 100 V, 50/60 Hz, 9.5 A</p> 	<p><b>Clamp, CW30014</b> (P/N 037-60091-03)</p>
<p><b>Organic Solvents Water-Cooled Chamber System</b> (P/N 211-92880-41)</p> <p>This kit includes chamber, drain, and some parts attached them. In addition to this kit, torch and cooling water circulator (Thermostat, NCB-1210B SP) are required for new purchase.<sup>Note</sup></p>	<p><b>Hydrofluoric Acid Sample Injection System</b> (P/N 211-92881-41)</p> <p>This kit includes torch, chamber, extension pipe, nebulizer, drain and some parts attached them. In addition to this kit, orifice S2 ASSY is required for new purchase.</p>



(Note) With certain types of organic solvents, e.g., ethanol, IPA, etc., axial observations are possible. In such cases, Orifice S2 ASSY (P/N 211-88571-42) must also be ordered. Note that at the time of installation, it will be necessary to set up the software.

# Peripheral Equipment

For automatic analysis of 60 samples  
**AS-10 Autosampler**  
 (P/N 211-93680-58)



Multiple samples can be analyzed successively. The turntable results in a short path length for sample injection, which can reduce the rinse time.

Vials: 60 15-mL vials  
 8 50-mL vials  
 Size: W290 × D508 × H300 mm (excluding arm)  
 Power supply: Single-phase 100–240 V, 50/60 Hz, 50 VA

Note: Requires a Power Cord.  
 Note: An additional rinsing port is optional (There is no automatic solvent supply).  
 Rinsing Port Expansion Kit for AS-10 (P/N 211-94072-41)

For automatic analysis of 240 samples  
**ASX-560 Autosampler**  
 (P/N 211-94230-01)

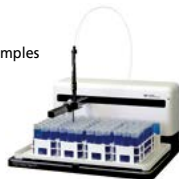

Vials:  
 10 50-mL vials (standard samples) or 240 14-mL vials  
 160 20-mL vials (rack sold separately)  
 84 50-mL vials (rack sold separately)  
 Size: W580 × D550 × H620 mm (include sample probe)  
 W90 × D180 × H60 mm (rough dimensions of power supply unit)

Power supply: 100-240 V AC, 47-63 Hz, 1.9 A  
 Weight: 11.7 kg (main unit)  
 Note: Requires an ASX Connection Kit ICPE-9800 (P/N 211-94610-41).

For automatic analysis of 120 samples  
**ASX-280 Autosampler**  
 (P/N 211-94412)



Vials:  
 10 50-mL vials (standard samples) or 120 14-mL vials  
 80 20-mL vials (rack sold separately)  
 42 50-mL vials (rack sold separately)  
 Size: W355 × D550 × H620 mm (include sample probe)  
 W90 × D180 × H60 mm (rough dimensions of power supply unit)

Power supply: 100-240 V AC, 47-63 Hz, 1.9 A  
 Weight: 8.1 kg (main unit)  
 Note: Requires an ASX Connection Kit ICPE-9800 (P/N 211-94610-41).

Quality Control Software  
**ICPEsolution QAQC**  
 (P/N 211-49146-91)

This software is based on QAQC items obtained USEPA CLP SOW ILM05.x.

For high-sensitivity analysis of As, Se, and Sb  
**Hydride Generator HVG-1**  
 (P/N 206-17143-41 to 58)



Note: HVG-ICP Connection Kit for ICPE-9800 (P/N 211-92481-58) and pump are required.

For high-sensitivity analysis of Na or K in organic solvent samples  
**Argon and Oxygen Gas Mixture Supply Unit (special order)**

Normally, the ICPE-9800 does not require oxygen gas to be added to the plasma when organic solvent samples are measured. However, when trace amounts (ppb levels) of elements such as Na and K in organic solvent are measured, carbon can cause background problems. A four-layered torch is useful for reducing such problems by introducing oxygen safely into the plasma.

Cooling Water Circulator  
 (P/N 211-92962-41)

Used to cool the main unit, the cooling jacket, and the ultrasonic nebulizer.

Size: W377 × D500 × H615 mm  
 Power supply: AC 200 V–230 V, 50/60 Hz, 2 kVA  
 Weight: 43 kg

Note: A Chiller Connection Kit (P/N 211-93827-41), or a Chiller Connection Kit, UAG (P/N 211-92894-42) is necessary.  
 Note: Two hoses (10 m) are included in the connection kit. One is for the supply of cooling water, the other for draining water.



Tap Water Connection Kit  
 (P/N 211-90558-41)

This is required if using tap water to cool the main ICPE-9800 unit.  
 Note: A Coupler Set for Tap Water Connection (P/N 035-60942-15) is required.

For reducing the suction volume of small amounts of samples by half  
**Nebulizer, 07UES**  
 (P/N 046-00092-21)

A nebulizer with high-efficiency nebulization.  
 (Sample suction rate of approx. 0.6 mL/min)

- Suction Tube, NFTS-075 (P/N 046-00092-18)
  - Connector, Q5M (P/N 046-00092-09)
  - Tube adaptor, 0735 (P/N 046-00092-10)
  - Clamp, SNP-1 (P/N 037-61113-01)
- These are included.



Peristaltic Pump  
 (P/N 211-92430-41)

Installed internally, with up to four channels  
 Size: W121 × D174 × H131 mm (excluding protrusions)  
 This pump is also used with the automatic internal standard addition kit.



For adding internal standards automatically to ensure accurate analysis with ease  
**Automatic Internal Standard Addition Kit**  
 (P/N 211-92883-41)

This kit is used for in-line mixing of a sample solution to be measured and an internal standard element solution and for introducing the mixture into the ICP system.

Note: Peristaltic Pump (P/N 211-92430-41) is required.

## Option (Third-Party)

Hydride Generator hydride FAST/Manufactured by Elemental Scientific Inc. Ultrasonic Nebulizer U5000AT/Manufactured by CETAC Technologies Inc.

ESI:  
 ESI's hydride ICP Generation System is used to concentrate hydride forming elements before analysis with Shimadzu's ICPE-9800 Series.  
 By increasing the concentration, sensitivity of the ICP spectrometer increases for elements like Hg, Se, As, Sn, Te and Bi.

CETAC:  
 CETAC U-5000AT\* Ultrasonic Nebulizer for ICPE-9800 Series. Increase sensitivity about a factor of 10x, but varies element to element. General use is for aqueous solutions.

IsoMist:  
 Temperature-controlled sample introduction kit. The temperature is electronically controlled using a powerful inbuilt Peltier device. You can select any temperature between -10°C and +60°C in 1°C increments to provide the optimum conditions for any application. The rapid response of the Peltier device allows a spray chamber temperature of -5°C.

Twister Spray chamber:  
 Used for non-volatile organics. The Twister cyclonic spray chamber features a central transfer tube which acts as a secondary particle separator helping separate larger aerosol particles from the sample. This reduces solvent load in the plasma without compromising detection limits.

## Installation Requirements for ICPE-9800 Systems

1. Installation room environment	Temperature: 18°C to 28°C (rate of temperature change: 2°C/h or lower) Humidity: 20% to 70% Avoid locations with high levels of vibration or dust.
2. Power supply	Main unit Single-phase, 200/220/230/240 V ± 10%, 50/60 Hz, 6 kVA Option Cooling Water Circulator Single-phase, 200 V–230 V, 50/60 Hz, 2 kVA
3. Grounding	Should be grounded independently with a maximum resistance of 30.
4. Gas equipment	Type: Argon gas of 99.95% or greater purity Make adjustments so that argon gas is supplied at 450 ± 10 kPa. Approximately one 7-m <sup>3</sup> cylinder is required for about 8 hours of operation. With the standard specifications, the consumption rate of argon gas used in analysis is 0.74 m <sup>3</sup> /h.
5. Cooling water	Plasma stand cooling water: Water temperature of 5°C to 30°C; flow rate of 1.5 L/min or more
6. Exhaust duct	Exhaust gas from the plasma stand is primarily argon; however, be sure to install an exhaust duct, since the gas may also contain metallic vapors and solvents.
7. Weight	210 kg

## Size

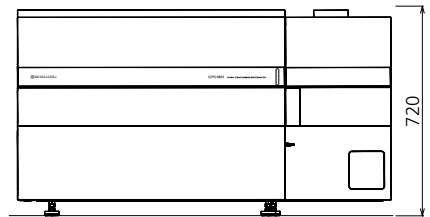
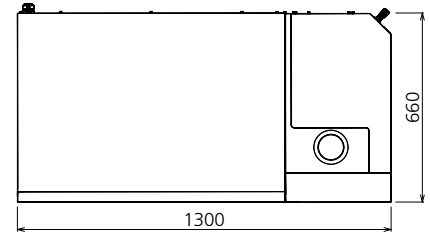

Units: mm

## Installation Example

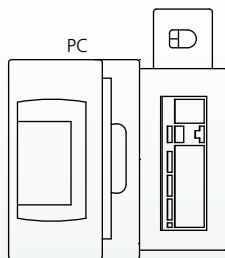
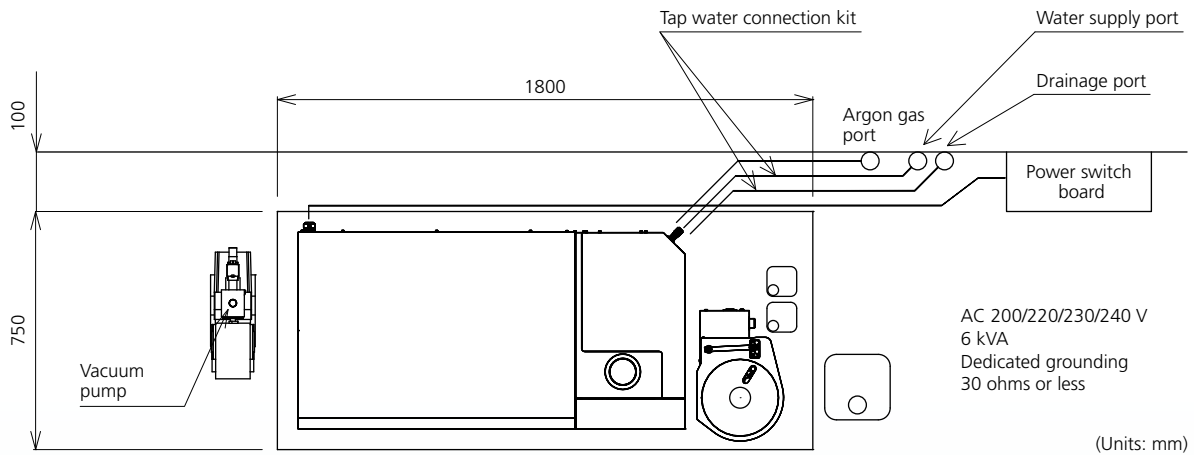



Shimadzu Corporation  
[www.shimadzu.com/an/](http://www.shimadzu.com/an/)

**For Research Use Only. Not for use in diagnostic procedures.**

This publication may contain references to products that are not available in your country. Please contact us to check the availability of these products in your country.

Company names, products/service names and logos used in this publication are trademarks and trade names of Shimadzu Corporation, its subsidiaries or its affiliates, whether or not they are used with trademark symbol "TM" or "®".

Third-party trademarks and trade names may be used in this publication to refer to either the entities or their products/services, whether or not they are used with trademark symbol "TM" or "®".

Shimadzu disclaims any proprietary interest in trademarks and trade names other than its own.

The contents of this publication are provided to you "as is" without warranty of any kind, and are subject to change without notice. Shimadzu does not assume any responsibility or liability for any damage, whether direct or indirect, relating to the use of this publication.